





MINI DOUBLE ASSEMBLY INSTRUCTIONS

-  X16
cam lock bolts
-  X16
cam locks
-  X16
caster screws
-  X4
wood dowels

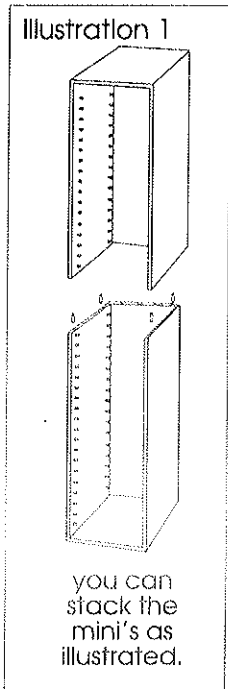

STEP 1
Screw the black cam-lock bolts into the pre-drilled holes on the top, bottom and side plates.

STEP 2
Push the cam-locks into the larger holes in the back and side plates as shown. (Make sure the arrow/triangle on the camlock is pointing towards pre-drilled hole in side of panel. See fig. A)

STEP 3
Use the 16 caster screws to attach casters to the bottom plate in pre-drilled starter holes.

STEP 4
Assemble the bottom section. First fasten side plates to back plate by sliding cam-lock bolts into cam-locks and turn clockwise to fasten tightly. Then fasten the assembly to the bottom plate.

STEP 5
Assemble the top section in the same manner.

STEP 6
Stand bottom section upright. Insert wood dowels into holes at top of side plates in bottom section. Stack top section over bottom section, and unit is complete.

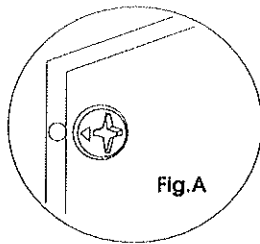
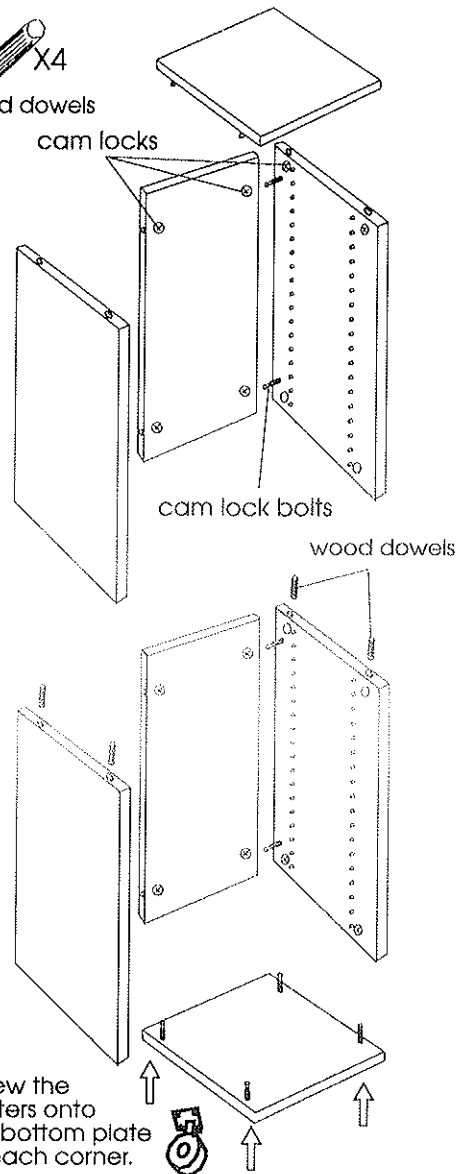

RAIL INSTRUCTIONS

Left & Right drawer rails can easily be pushed into the pre-drilled holes along the sides of the cabinet. When removing rails, DO NOT TWIST, just lightly wiggle until the rail is loose enough to pull out.

PLEASE NOTE;
The bottom drawer does not require a rail. It slides along the bottom of the cabinet.

The metal dowels are for the paper shelves. The paper shelf will clip onto the rear dowel. A light push will release the shelf so you can remove it.

